

Catalogo

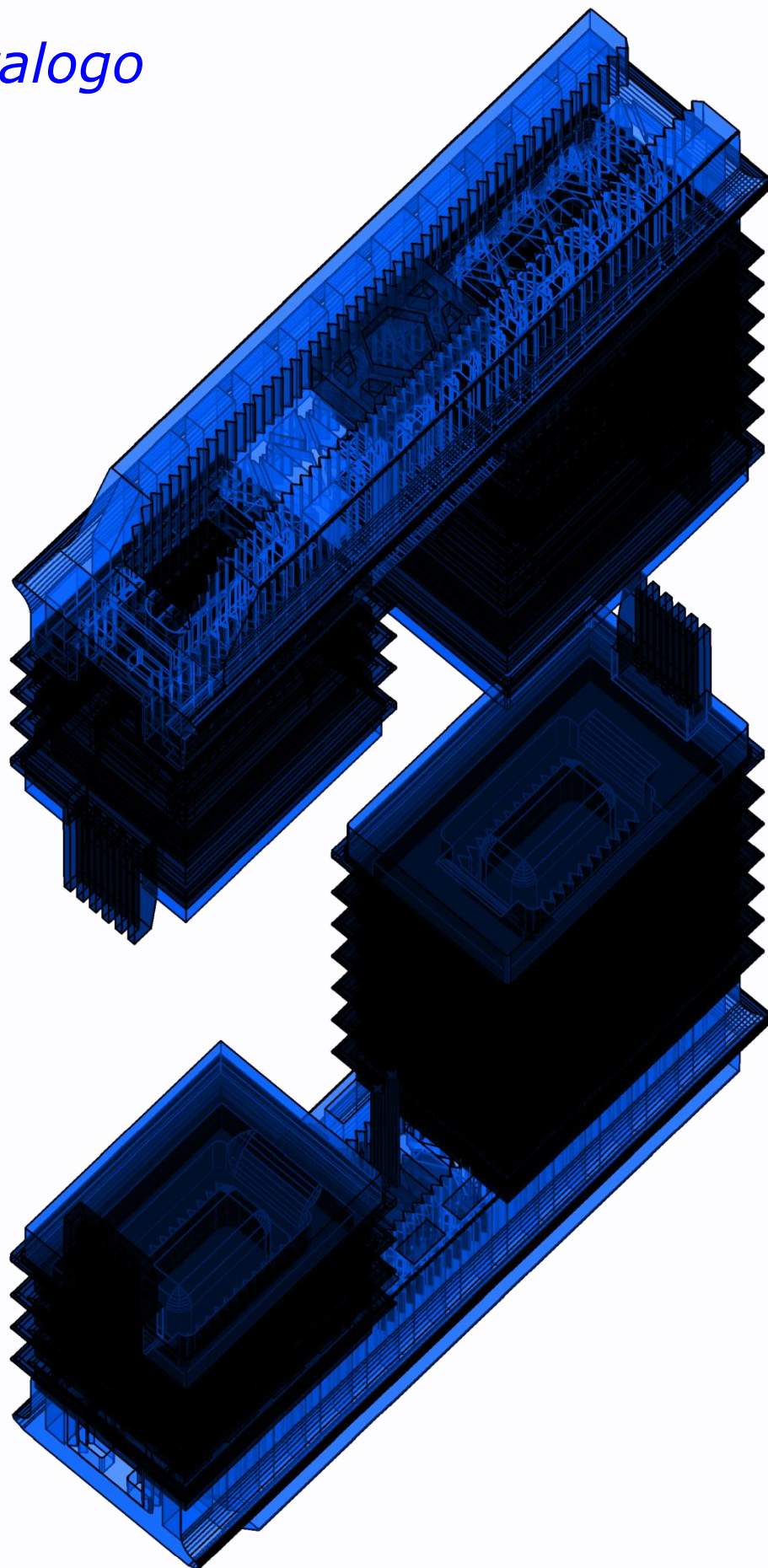

CGSPLAST
WE SUPPORT TECHNOLOGY



Serie 700 hp

Catalogo

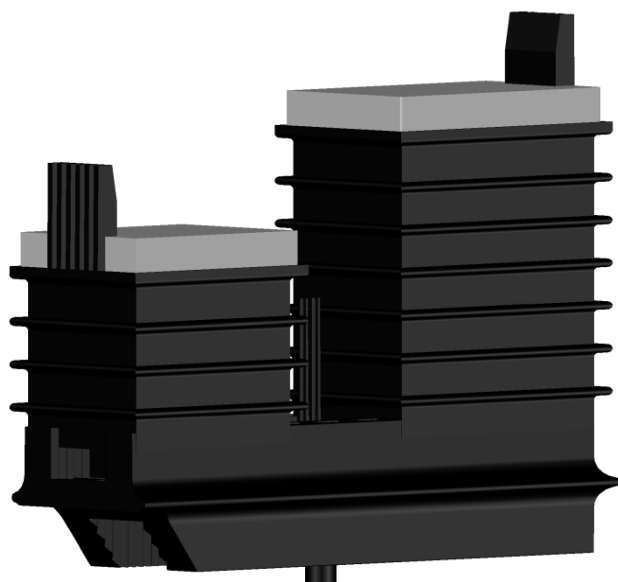
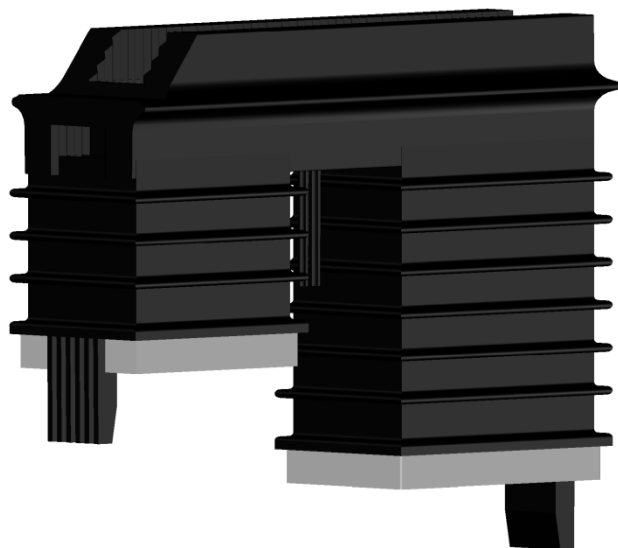

Sistema di fissaggio bobine per trasformatori fino a 10 MVA
Nata dall'evoluzione della serie 700 per soddisfare le esigenze dell'industria eolica ed anti sismica.
Versatile e modulare con componenti stampati in tecnopolimero rinforzato al 50% con fibra di vetro e temperatura di inflessione (HDT) di 210°C
Possibilità di estensione fino a 16 MVA previo consultazione con il nostro ufficio tecnico.

Componenti

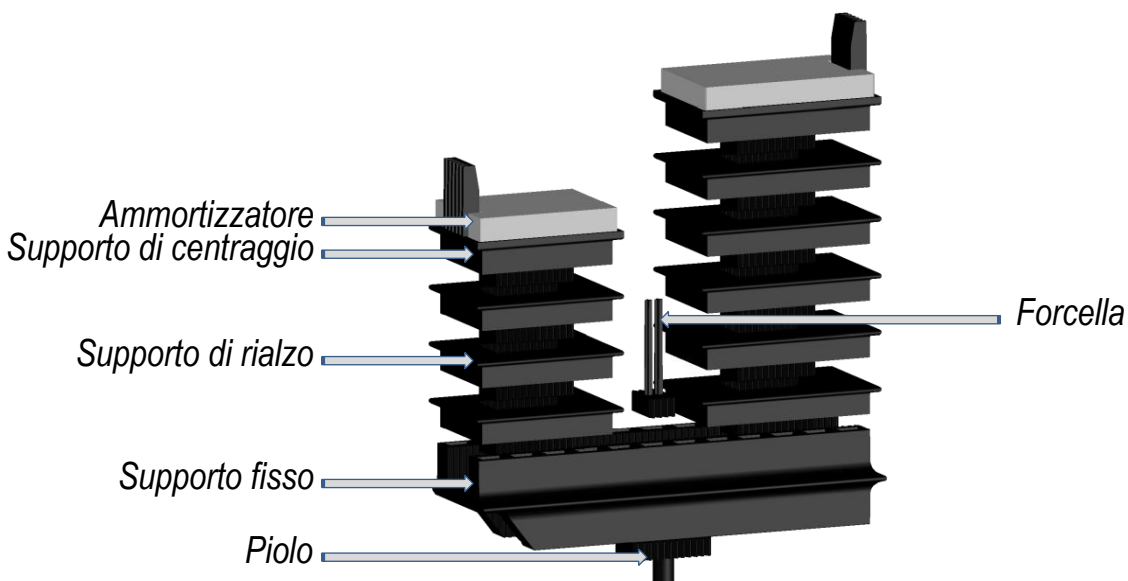
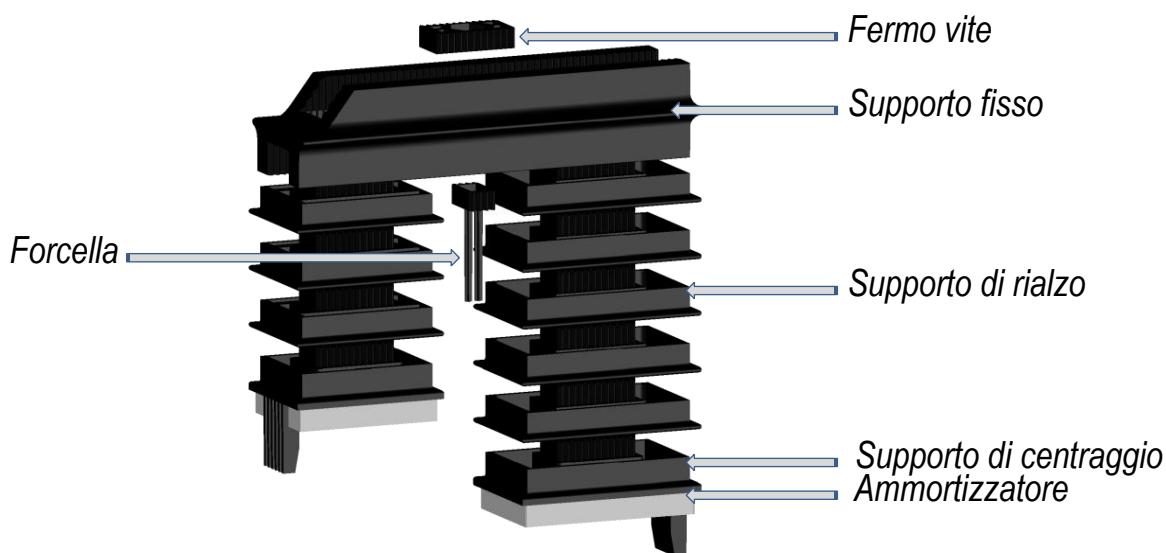

Supporti fissi

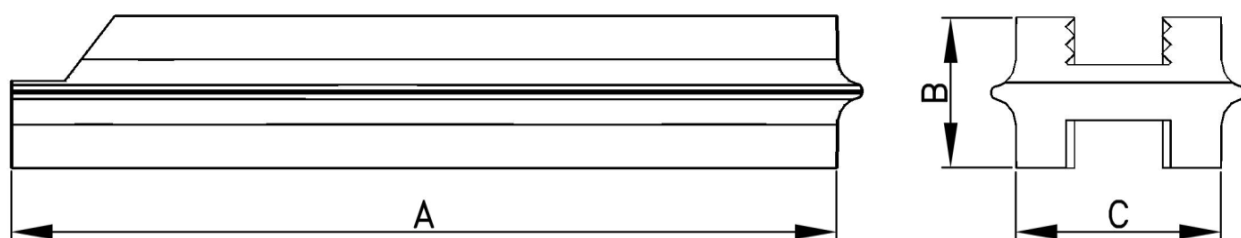

Codice	A mm	B mm	C mm
702.140 hp	140	40	60
702.160 hp	160	40	60
702.180 hp	180	40	60
702.200 hp	200	40	60
702.220 hp	220	40	60
702.240 hp	240	40	60
702.260 hp	260	40	60
702.280 hp	280	40	60



Serie 700 hp

Supporti fissi h 40 mm

Supporti fissi

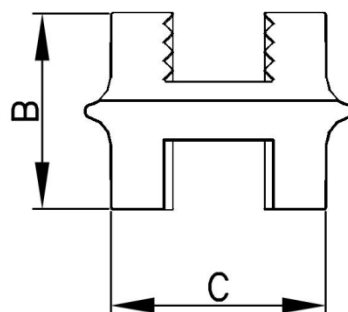
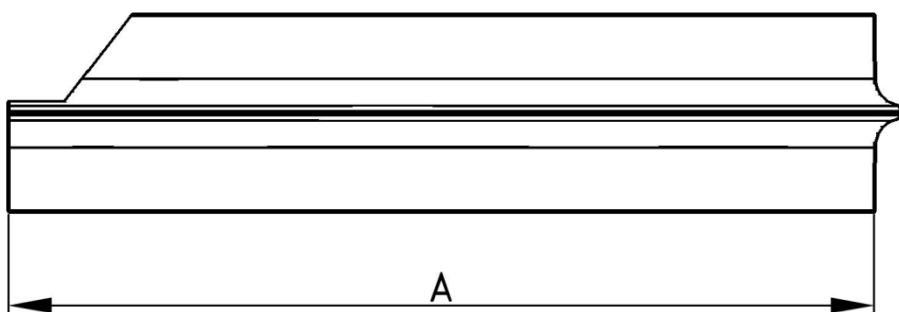

Codice	A mm	B mm	C mm
701.140 hp	140	50	60
701.160 hp	160	50	60
701.180 hp	180	50	60
701.200 hp	200	50	60
701.220 hp	220	50	60
701.240 hp	240	50	60

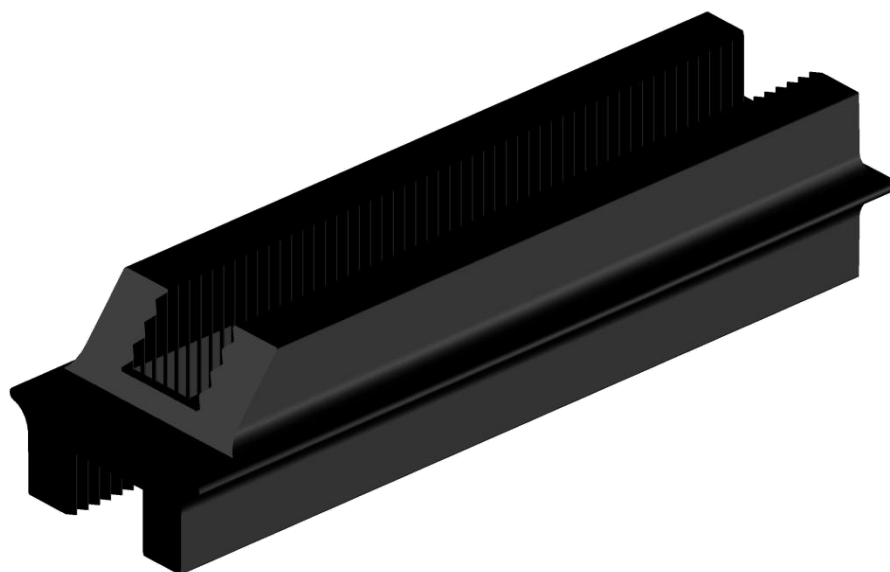

Serie 700 hp

Supporti fissi h 50 mm

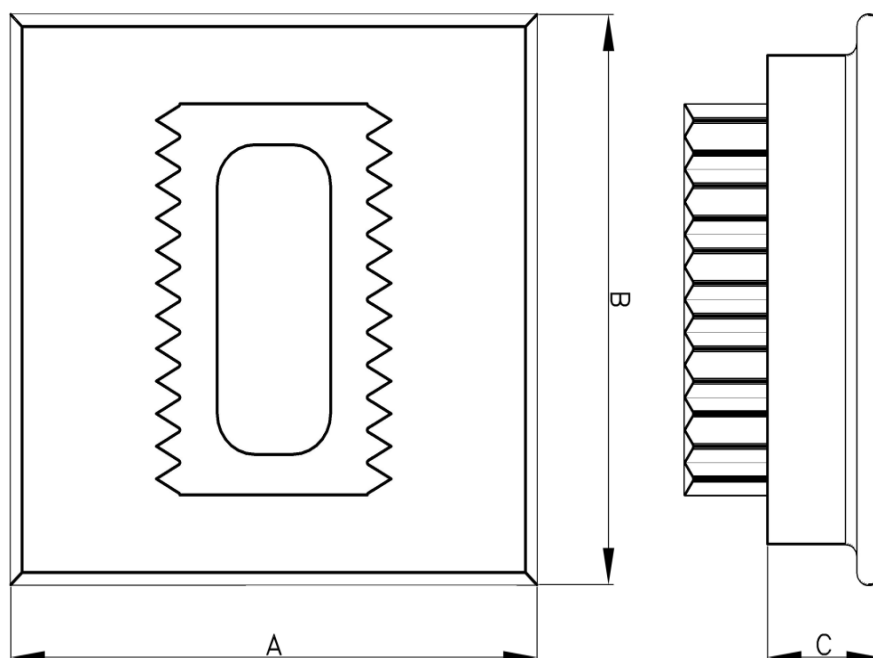

Codice	A mm	B mm	C mm
711.045 hp	70	45	15
711.015 hp	70	70	15
711.090 hp	70	90	15
711.110 hp	70	110	15

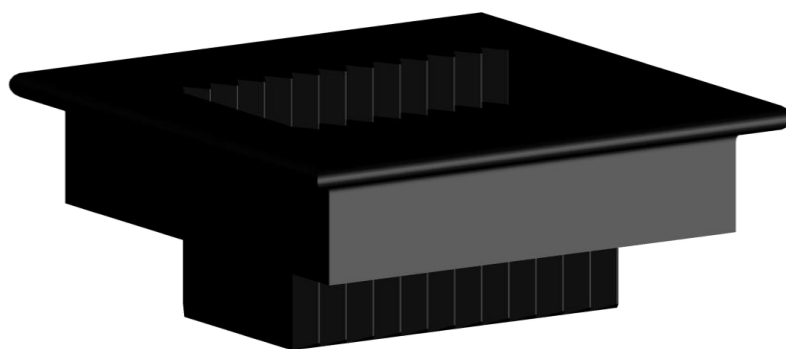

Supporti di rialzo diam.70 mm

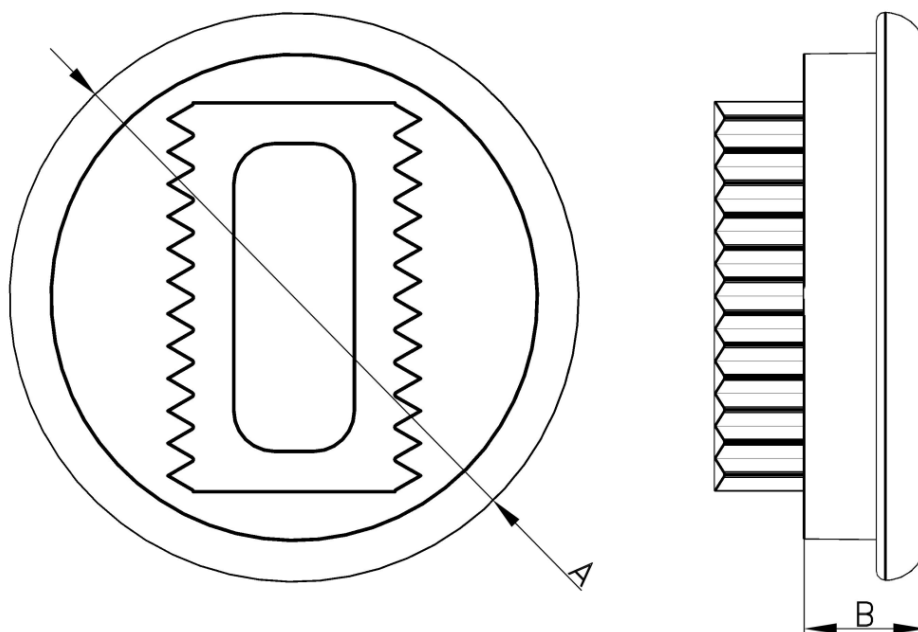

Codice	A mm	B mm
712.015 HP	70	15

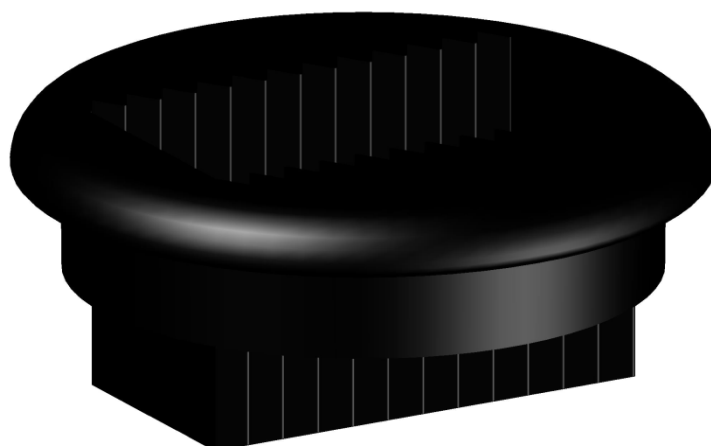

Serie 700 hp

Supporti di rialzo diam. 70 mm



CGSPLAST
WE SUPPORT TECHNOLOGY

Supporti di centraggio con paletta

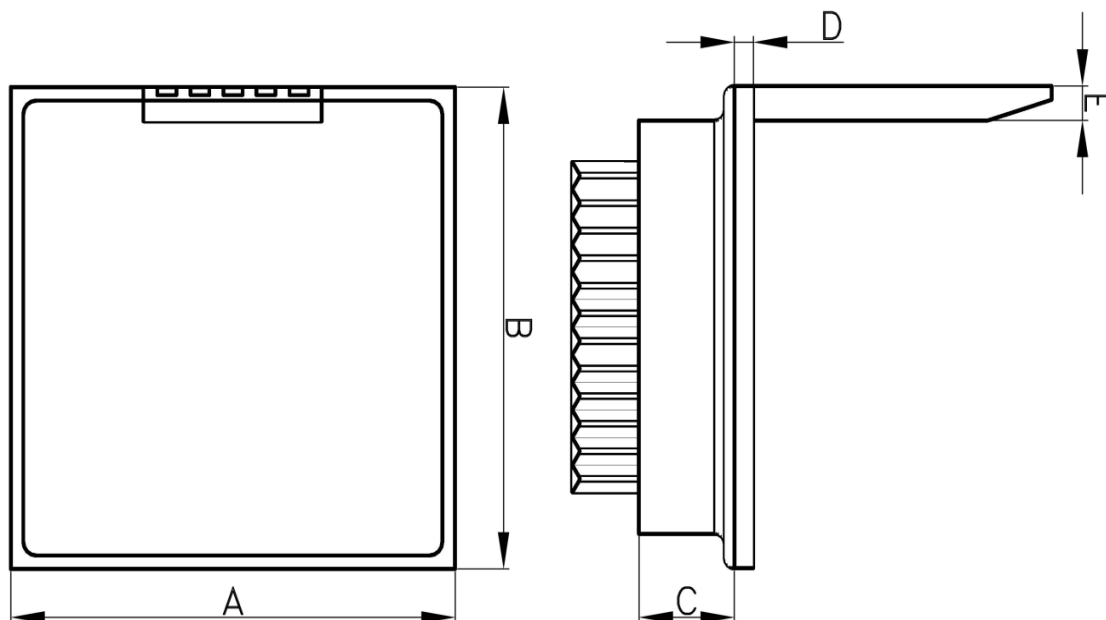

Codice	A mm	B mm	C mm	D mm	E mm
724.015 hp	70	70	15	3	5
724.090 hp	70	90	15	3	10
724.110 hp	70	110	15	3	10

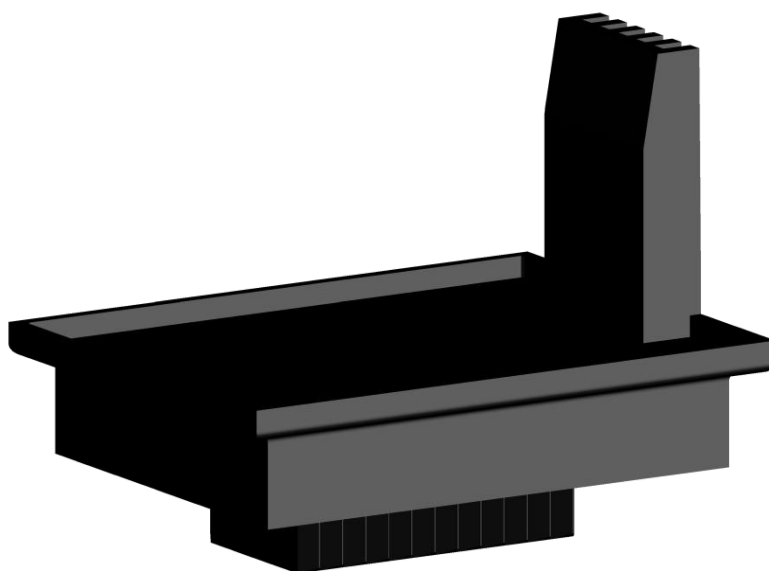

Serie 700 hp

Supporto di centraggio con paletta

Supporti di centraggio senza paletta



CGSPLAST
WE SUPPORT TECHNOLOGY

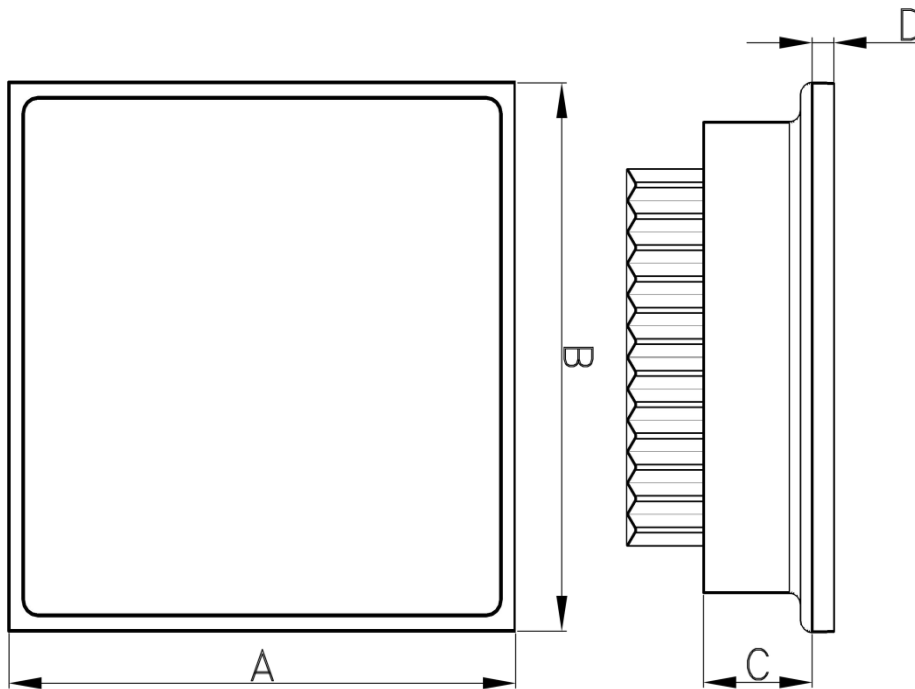

Codice	A mm	B mm	C mm	D mm
722.045 hp	70	45	15	3
722.015 hp	70	70	15	3
722.090 hp	70	90	15	3
722.115 hp	70	110	15	3

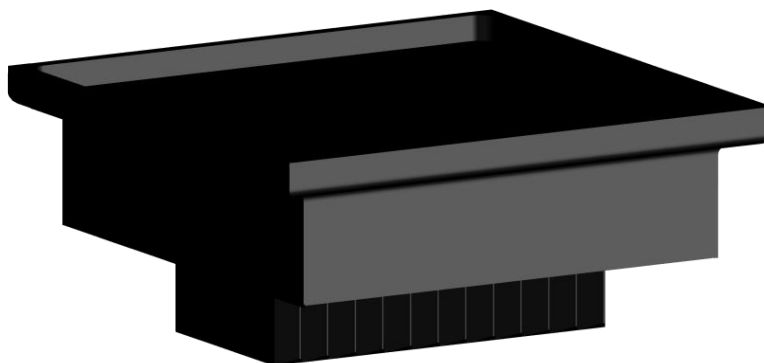

Serie 700 hp

Supporto di centraggio senza paletta

Forcella



CGSPLAST
WE SUPPORT TECHNOLOGY

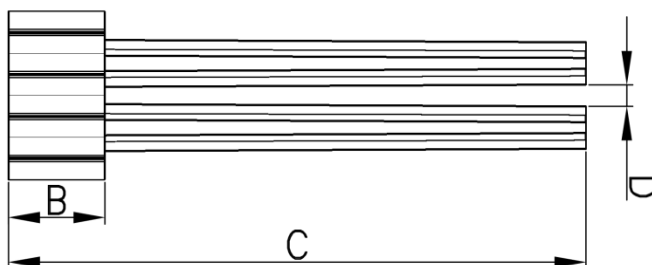
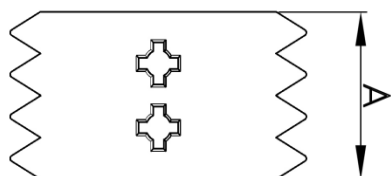

Codice	A mm	B mm	C mm	D mm
771.000 hp	16	10	60	1,6

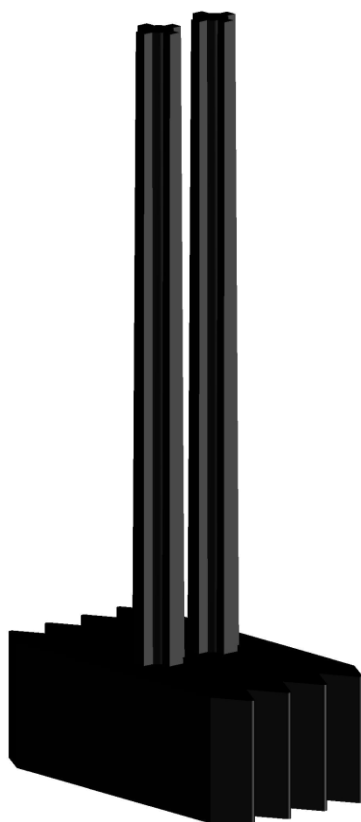

Serie 700 hp

Forcella

Fermi vite

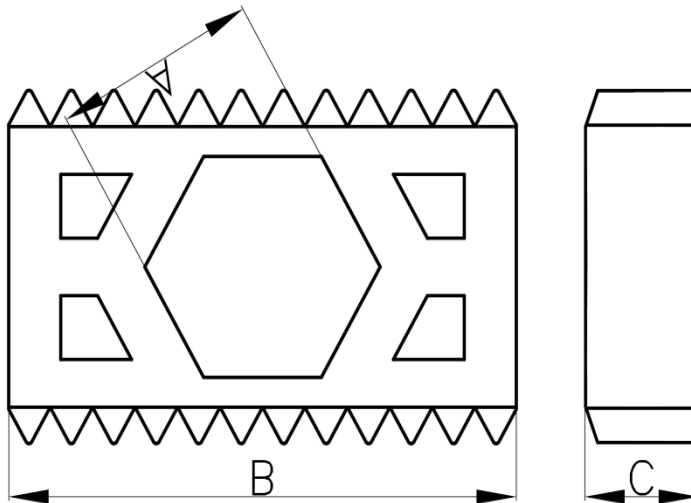

Codice	A mm	B mm	C mm
741.001 hp	19,4	47,8	10,7

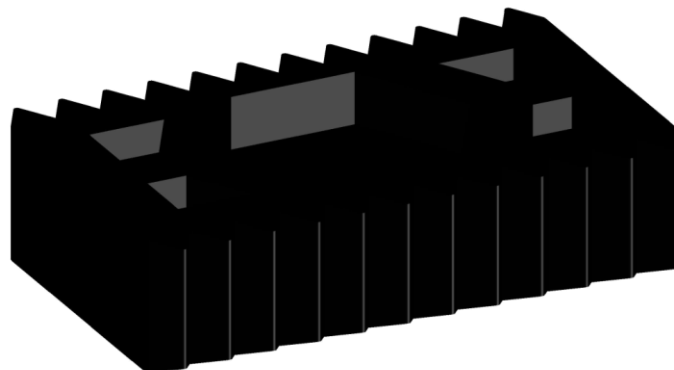

Piolo



CGSPLAST
WE SUPPORT TECHNOLOGY

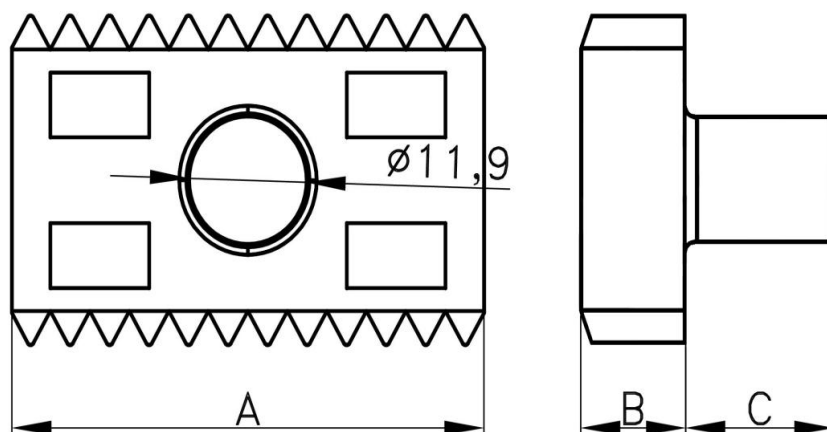

Codice	A mm	B mm	C mm
751.000 hp	47,8	10,7	15

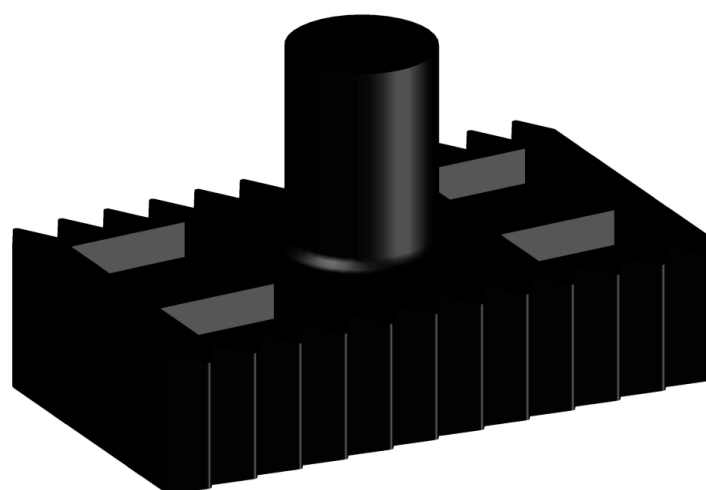

Serie 700 hp

Piolo

Giunto



CGSPLAST
WE SUPPORT TECHNOLOGY

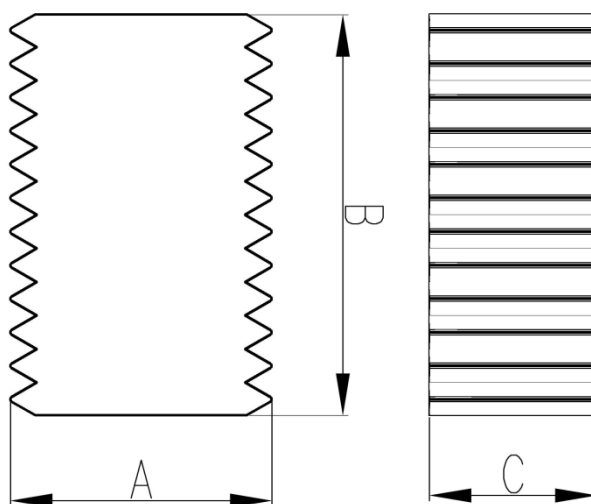
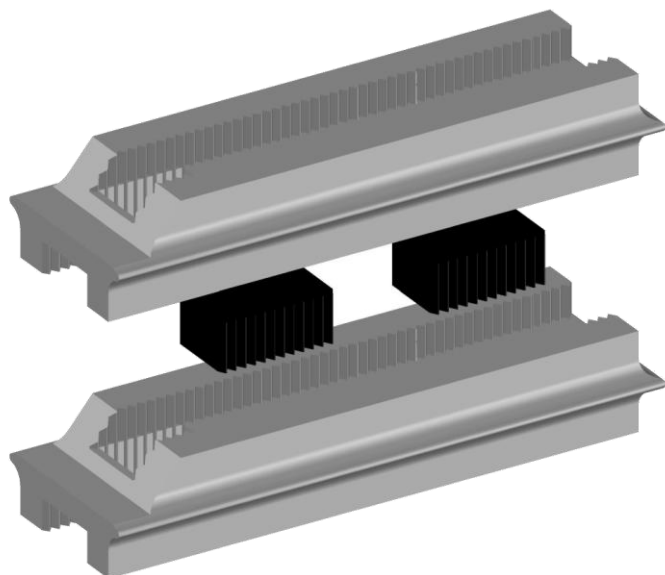

Codice	A mm	B mm	C mm
781.000 hp	31,2	47,8	20

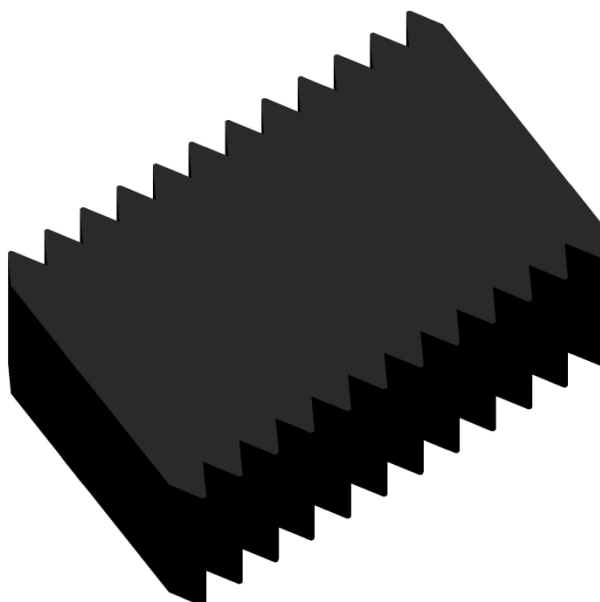

Serie 700 hp

Giunto



CGSPLAST
WE SUPPORT TECHNOLOGY

Ammortizzatore gomma siliconica supp. con paletta

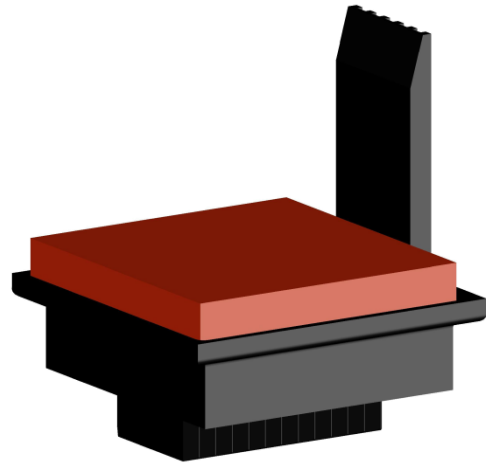
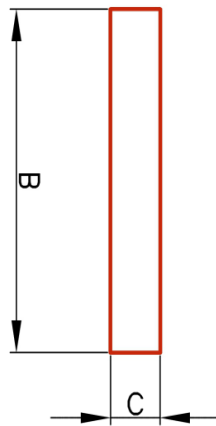
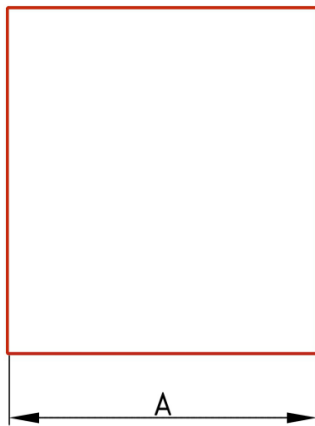

Codice	A mm	B mm	C mm	Materiale	Colore
733.005	62	64	5	Silicone	Rosso
733.010	62	64	10	Silicone	Rosso
733.015	62	64	15	Silicone	Rosso
733.020	62	64	20	Silicone	Rosso
733.705	75	64	5	Silicone	Rosso
733.710	75	64	10	Silicone	Rosso
733.715	75	64	15	Silicone	Rosso
733.720	75	64	20	Silicone	Rosso
733.105	97	64	5	Silicone	Rosso
733.110	97	64	10	Silicone	Rosso
733.115	97	64	15	Silicone	Rosso
733.120	97	64	20	Silicone	Rosso

Serie 700 hp

Amm.gomma siliconica

Amm. gomma siliconica supp. senza paletta

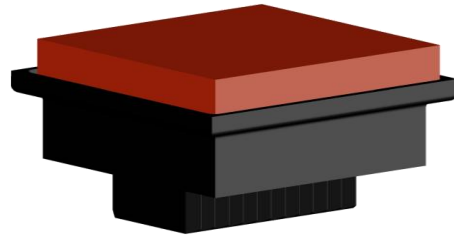
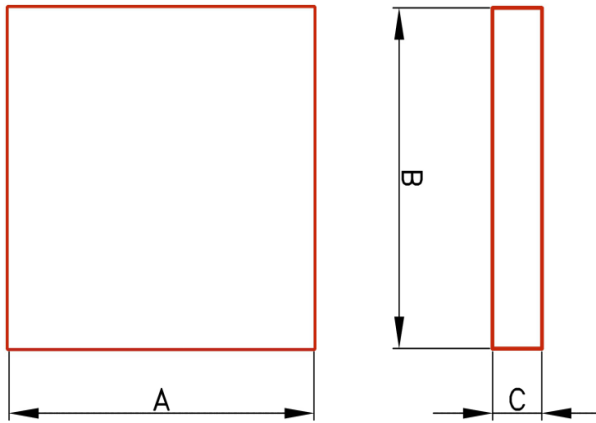

Codice	A mm	B mm	C mm	Materiale	Colore
733.405	39	64	5	Silicone	Rosso
733.410	39	64	10	Silicone	Rosso
733.415	39	64	15	Silicone	Rosso
733.420	39	64	20	Silicone	Rosso
734.005	64	64	5	Silicone	Rosso
734.010	64	64	10	Silicone	Rosso
734.015	64	64	15	Silicone	Rosso
734.020	64	64	20	Silicone	Rosso
733.905	84	64	5	Silicone	Rosso
733.910	84	64	10	Silicone	Rosso
733.915	84	64	15	Silicone	Rosso
733.920	84	64	20	Silicone	Rosso
734.105	104	64	5	Silicone	Rosso
734.110	104	64	10	Silicone	Rosso
734.115	104	64	15	Silicone	Rosso
734.120	104	64	20	Silicone	Rosso

Serie 700 hp

Amm.gomma siliconica



CGSPLAST
WE SUPPORT TECHNOLOGY

Ammortizzatore gomma siliconica supp. con incavo

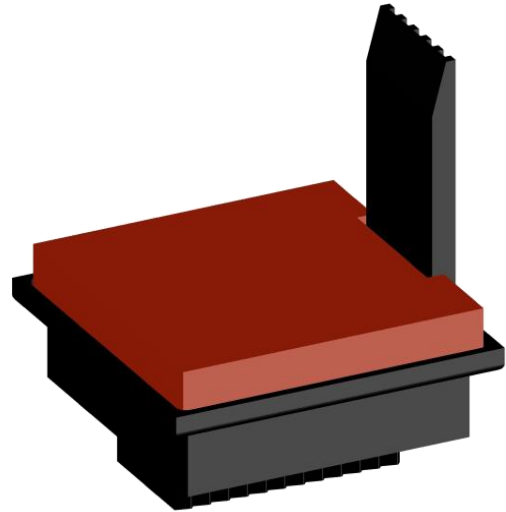
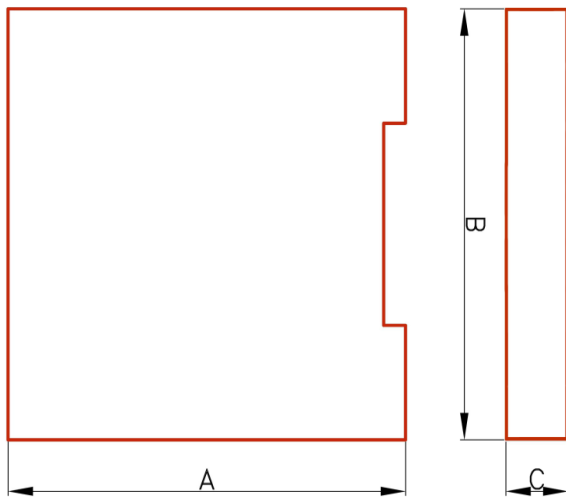

Codice	A mm	B mm	C mm	Materiale	Colore
737.005	64	64	5	Silicone	Rosso
737.010	64	64	10	Silicone	Rosso
737.015	64	64	15	Silicone	Rosso
737.020	64	64	20	Silicone	Rosso
737.905	84	64	5	Silicone	Rosso
737.910	84	64	10	Silicone	Rosso
737.915	84	64	15	Silicone	Rosso
737.920	84	64	20	Silicone	Rosso
737.105	104	64	5	Silicone	Rosso
737.110	104	64	10	Silicone	Rosso
737.115	104	64	15	Silicone	Rosso
737.120	104	64	20	Silicone	Rosso

Serie 700 hp

Amm.gomma siliconica

Amm. in EPDM supp. senza paletta

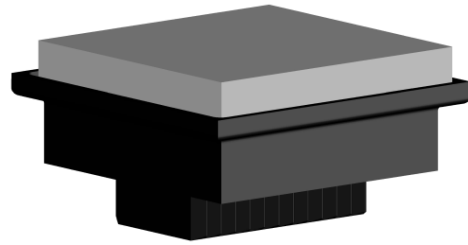
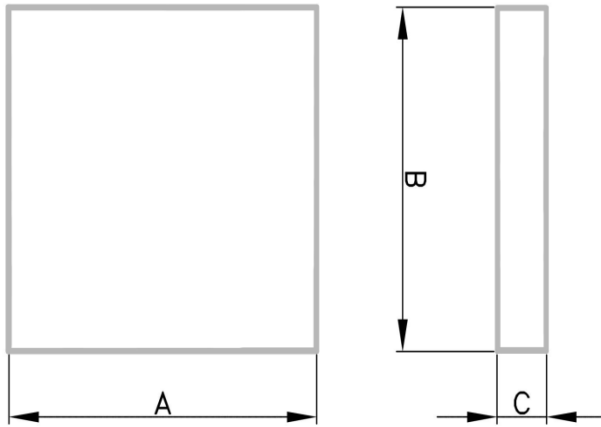

Codice	A mm	B mm	C mm	Materiale	Colore
735.405	39	64	5	EPDM	Grigio
735.410	39	64	10	EPDM	Grigio
735.415	39	64	15	EPDM	Grigio
735.420	39	64	20	EPDM	Grigio
735.005	64	64	5	EPDM	Grigio
735.010	64	64	10	EPDM	Grigio
735.015	64	64	15	EPDM	Grigio
735.020	64	64	20	EPDM	Grigio
735.905	84	64	5	EPDM	Grigio
735.910	84	64	10	EPDM	Grigio
735.915	84	64	15	EPDM	Grigio
735.920	84	64	20	EPDM	Grigio
735.105	104	64	5	EPDM	Grigio
735.110	104	64	10	EPDM	Grigio
735.215	104	64	15	EPDM	Grigio
735.220	104	64	20	EPDM	Grigio

Ammortizzatori in EPDM con incavo

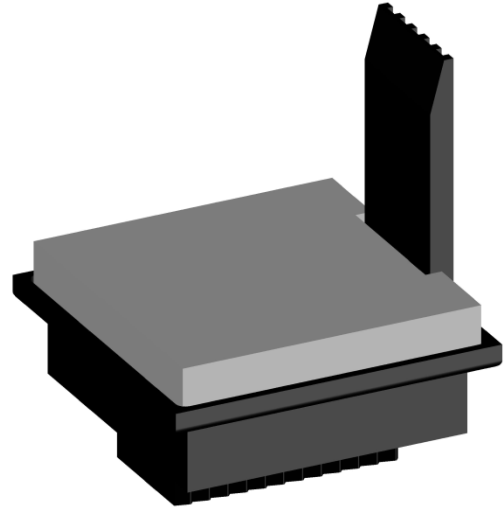
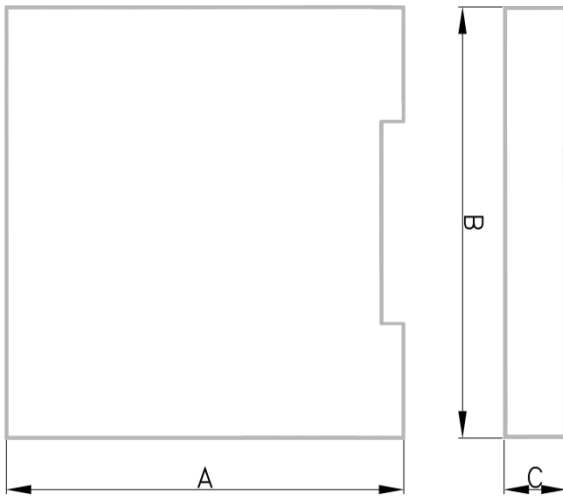

Codice	A mm	B mm	C mm	Materiale	Colore
736.005	64	64	5	EPDM	Grigio
736.010	64	64	10	EPDM	Grigio
736.015	64	64	15	EPDM	Grigio
736.020	64	64	20	EPDM	Grigio
736.905	84	64	5	EPDM	Grigio
736.910	84	64	10	EPDM	Grigio
736.915	84	64	15	EPDM	Grigio
736.920	84	64	20	EPDM	Grigio
736.105	104	64	5	EPDM	Grigio
736.110	104	64	10	EPDM	Grigio
736.215	104	64	15	EPDM	Grigio
736.220	104	64	20	EPDM	Grigio



CGSPLAST

WE SUPPORT TECHNOLOGY

Strada Longa 809, n° 8
26815 Massalengo (LO)
Italy

Phone: +39 0371 070025

Fax: +39 0371 070026

info@cgsplast.com

www.cgsplast.com

